

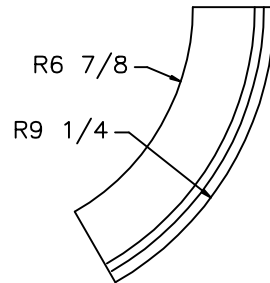

LJ-6010  
PROFILE

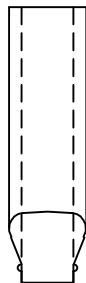
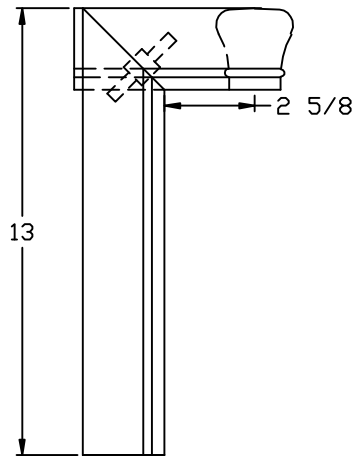
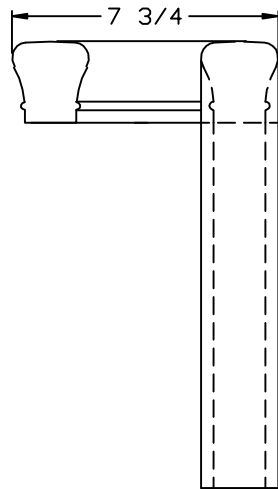
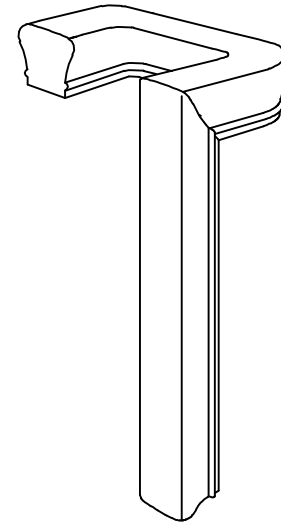
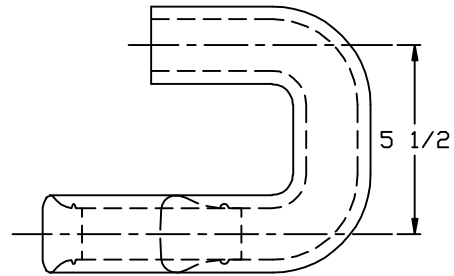
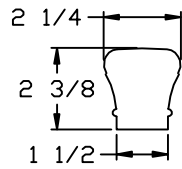

 <b>L.J. Smith</b> <b>Stair Systems</b>		
35280 Scio-Bowerston Road Bowerston, OH 44695-9731 Phone (740) 269-4111 FAX (740) 269-9047 <small>This drawing is the property of L.J. Smith Co. Do not use or copy without permission from L.J. Smith.</small>		
Drawing Name		
S-7090-2		
Date	Scale	Drawn By
05/29/2008	DO NOT SCALE	DLJ
File Name	DESTROY PREVIOUS PRINTS	
S7090	SALES	