

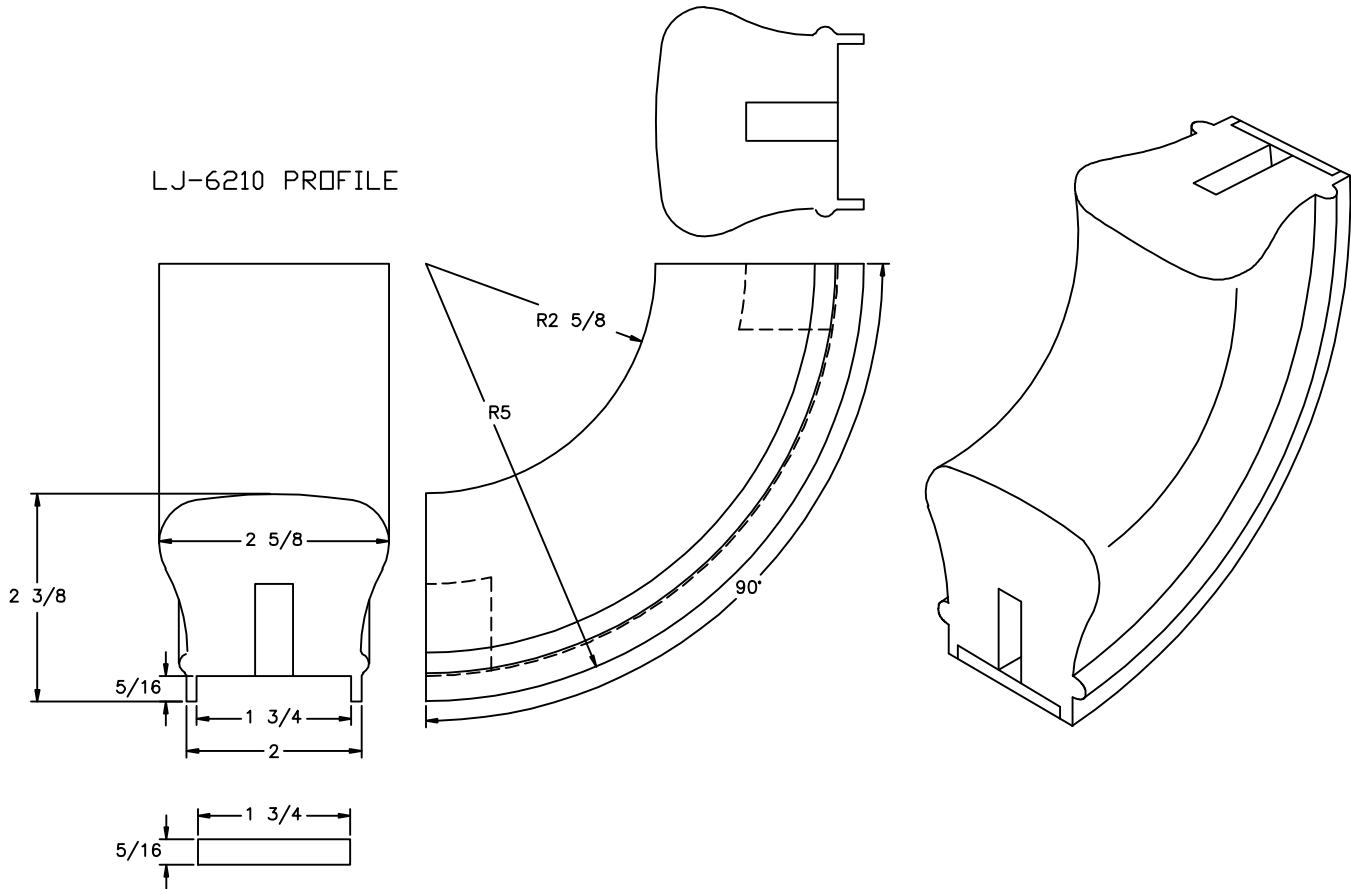

LJ-6210 PROFILE



LJ-1214F FILLET
 CONECT-A-KIT PATENT NO. 5,261,201

 <p>35280 Scio-Bowerston Road Bowerston, OH 44695-9731 Phone (740) 269-4111 FAX (740) 269-9047 This drawing is the property of L.J. Smith Co. Do not use or copy without permission from L.J. Smith.</p>		
Drawing Name		
LJ-7214P		
Date	Scale	Drawn By
03/16/01	DO NOT SCALE	KJP
File Name	DESTROY PREVIOUS PRINTS	
LJ7214	SALES	